



# Pipe Frost Protection

## Application manual



# Index

1. Application briefing	4
2. System Description	5
3. Products	7
4. System design	11
5. Installation	20
6. Cases	28

# Let DEVI do the work

DEVI - an abbreviation of Dansk El-Varme Industri - was established in Copenhagen, Denmark, in 1942. As from January 1st 2003 DEVI has become a part of the Danfoss Group - Denmark's largest industrial Group. Danfoss is one of the world's leading companies within heating, cooling and air-conditioning. The Danfoss Group has more than 23000 employees and serves customers in more than 100 countries.

DEVI is Europe's leading brand of electrical cable heating systems and electric pipe heating systems with over 70 years of experience. The production of heating cables takes place in France and Poland while the head office is situated in Denmark.

## Pipe Frost Protection

This design guide presents DEVI's recommendations for design and installation of frost protection for pipes. It provides guidance for heating cable layout, electrical data and system configurations.

Following DEVI's recommendations will ensure energy efficient, reliable and maintenance free solution for constant wattage heating cables with 20 year warranty, self-limiting heating cables with 5 years of warranty.

Our quality management system **certifications and compliances**

✓ ISO 9001

✓ TS 16949

✓ ISO 14001

Along with full compliance with EU directives and product approvals



# 1. Application briefing

During the winter, problems with freezing in fresh water, waste water, cooling water, supply water and sprinkler systems can be avoided by internal or external pipe heating.

Pipes installed outdoor or inside unheated premises, even if insulated, can be subjected to low temperatures that results in ice generation inside pipes.

When water turns to ice its volume expands and in closed pipes ice becomes strong enough to cause pipe bursting. This results in damages, water leakage and costly repairs.

DEVI heating systems provide an affordable, easy to install and adjustable solution in the form of a thermostat regulated heating cable.

This solution provides a pipeline owner with a safe, maintenance free and sustainable system ensuring proper performance for years.

DEVI's pipe tracing systems can be used for inside and outside applications in individual pipes and pipelines as well as for overhead and buried pipelines.

## Benefits

- **Avoiding unforeseen repair costs:** Frost protection of pipes eliminates expensive repairs and replacements after a long cold winter.
- Secures **constant flow of water** in pipes, even in the coldest and unpredictable conditions.
- **Any installation areas:** Can be used on and in pipes, indoor, outdoor and in ground.
- **Approved for use in drinking water supply systems,** according to GDV certification.
- **Reduced cost of installation** in rocky and other ground types, by allowing shallower installation.
- Possibility for **retrofitting of insulated pipes.**



## 2. System Description

DEVI heating system provides a versatile solution for water pipes protection (including drinking water pipelines) against freezing.

**For on-pipe application:**

DEVIflex™ constant wattage cables or self-limiting cables (SLC) such as DEVIpipelineguard™, DEVIpipelineheat™ 10 V2 provide flexible and on-site cut-to-length solutions.

**For in-pipe application:**

DEVlaqua™ constant wattage cables.

The system is regulated by means of DEVIreg™ 330 or 610 electronic thermostats. This is needed for constant wattage cables and strongly advised for self-limiting cables (SLC) to prevent energy consumption during standby periods.

To ensure energy efficient solution the use of an aluminum tape for cable installation, thermal insulation of pipes and electronic thermostats for control are essential.

Electronic thermostats DEVIreg™ have a sensor placed directly on pipe to be protected under its insulation, and ensure optimal operation with minimal energy consumption.

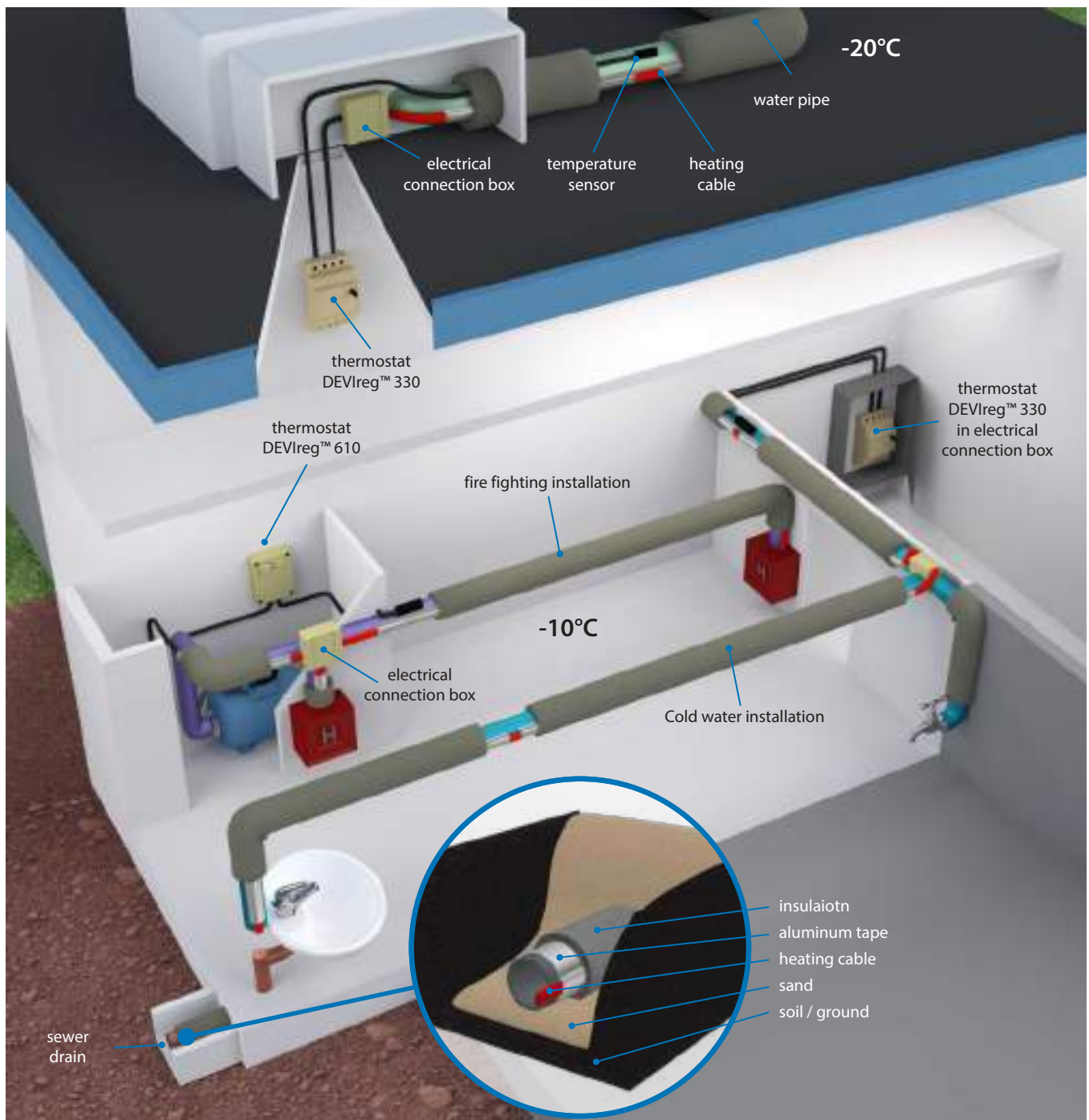

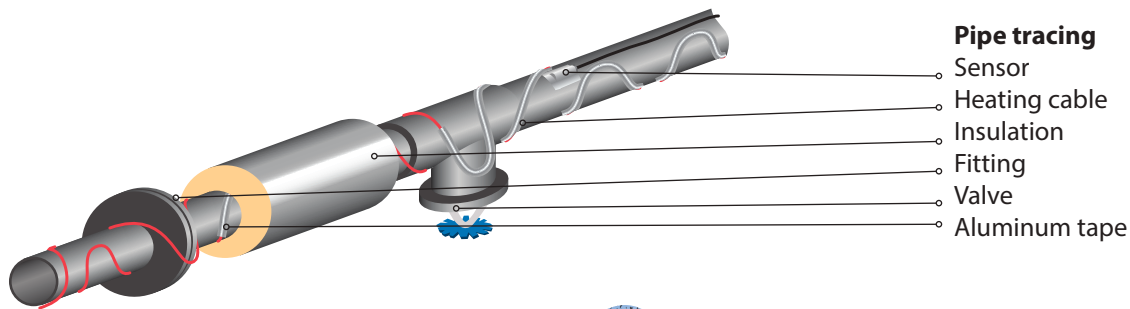

- Pipe tracing**
- Sensor
  - Heating cable
  - Insulation
  - Fitting
  - Valve
  - Aluminum tape

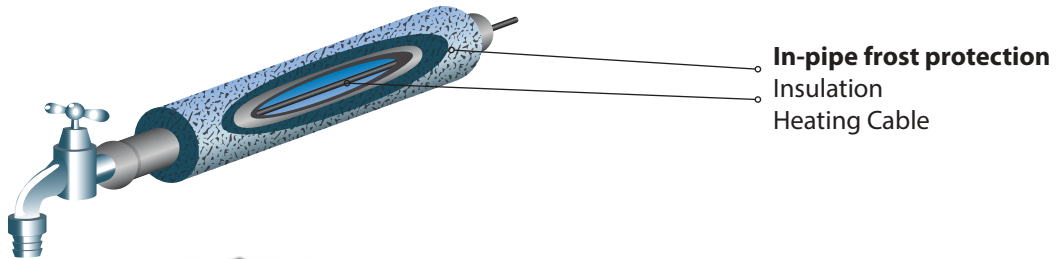

- In-pipe frost protection**
- Insulation
  - Heating Cable

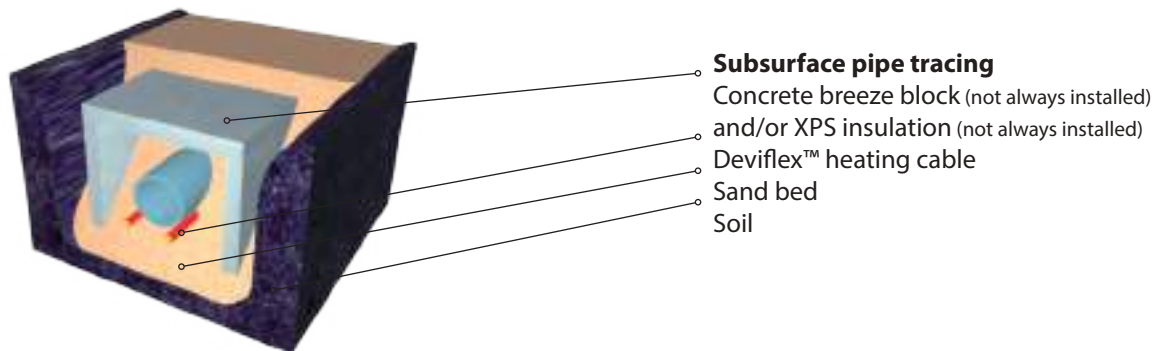

- Subsurface pipe tracing**
- Concrete breeze block (not always installed)
  - and/or XPS insulation (not always installed)
  - Deviflex™ heating cable
  - Sand bed
  - Soil

Heating cables can be used with either metal or plastic pipes (e.g. PVC, PE, PP etc.). Plastic pipes may have limitations with regard to the output of a heating cable installed.

For more information please refer to the design section of this Application Manual as well as confirm temperature limits for plastic pipes with your supplier.

Installations are divided in two general application categories:

- Inside buildings
- Outside buildings

The outside application category can be additionally divided into:

- in air
- in ground installation, as shown on the pictures above.

### Installation inside buildings

Water supply pipes installed inside buildings, where temperature may fall below 0 °C, e.g. unheated parking areas.

For such applications installation of electrical heating cables to ensure sustainable water flow and to prevent icing and subsequent pipe bursting is strongly advisable and in many cases required by law.

For further details investigate local building norms.

### Outside above ground installation

Pipes installed outside buildings are especially in need of frost protection.

The primary protection is ensured by insulation but often to protect pipes in extreme weather conditions or in course of economic feasibility it's advantageous to install an electrical heating system (cables and thermostat).

Examples of such installations can be found: on roofs of shopping arcades, office buildings, hotels or utility buildings like water stations.

### Outside in-ground installation

Water pipes insulated and protected with electrical heating systems can be installed in ground at a shallower depth.

In some areas, where the ground is composed of solid rock, this is the most economically feasible solution.

Location of electrical heating cables has to be clearly marked following local electricity laws. Marking shall include at least a yellow or red warning label indicating a supply voltage level. Additionally, if the cable is not protected by a concrete block, or similar, a thick plastic tape should be placed on top and slightly above the cable for its entire length. This is to minimize the possibility of mechanical damage during possible excavation activities in the future.

# 3. Products

## Heating cables

The following heating cables can be used for protection of water pipe heating systems:

Heating cables for on-pipe installation:

- Resistive (constant wattage):  
DEViflex™ 6T, DEViflex™ 10T,  
DEViflex™ 18T;  
DEVibasic™ 10S, DEVibasic™ 20S.
- Self-limiting cables (SLC;  
variable wattage):  
DEVipeheat™ 10 V2,  
DEVipeguard™ 10,  
DEVipeguard™ 25,  
DEVipeguard™ 33;  
DEVliceguard™ 18.

Heating cables for in-pipe installation:

- DEVIaqua™ 9T.

Mentioned as "in-pipe installation" is approved, according to GDV, for use in contact with drinking water.

The heating cable is relatively stiff, which makes the installation easier. The polyethylene coating prevents any output or taste alteration of drinking water.

Self-limiting heating cables are equipped with a temperature sensitive resistant element between two parallel copper conductors. When conductors are connected to the mains, the current flows through the temperature sensitive element which starts heating. As the element is heated, the resistance value rises causing the current decrease and then the heating is reduced. This explains the self-limiting output effect.

Such independent output regulation takes place on the entire cable based on the actual ambient temperature. When the ambient temperature rises, the cable heating output is reduced.

This self-limiting capability allows avoiding cable overheating even in case if two cables cross or touch each other.

Autonomous power supply of self-limiting heating cables allows their shortening or extending in any place. This simplifies cable planning and installation.





In order to limit power consumption the heating cable should switch on/off if it's length exceeds approx. 3 m, e.g. by using a DEVireg™ thermostat.

Resistive cables

DEVibasic™

DEViflex™

DEVIaqua™

Self-limiting cables

DEVipeheat™ 10 V2

DEVipeguard™ 10

DEVipeguard™ 25

DEVipeguard™ 33

DEVliceguard™ 18

## Thermostats

To control a pipe heating system DEVIreg™ 330 (5...45 °C) thermostat with DIN rail attachment and pipe or wall mounted DEVIreg™ 610 (IP44) are recommended.

All thermostats are equipped with wire temperature sensors in set – NTC 15 kOhm @ 25 °C, 3 m.



SLC to box connection set (#19400100)

## Fixing & Connection

Attaching cable to metal or plastic pipes is recommended by means of adhesive aluminum tape.

A large choice of connection sets, shrink tube or system-sets is available for connection and interconnection of heating cables (including SLC) to power supply and to each other. See also the next page.



SLC connection set (#19400126)

A larger variety of connecting accessories (fixed as well as based on shrinking-tube) for self-limiting heating cables is available.

For more information please refer to the DEVI product program or contact your local DEVI provider.



Glued aluminum tape with warning signs (#19805076)



DEVIreg™ 330



DEVIreg™ 610



Connection box (#19400167)



# DEVI EasyConnect

## EC-1 (98300870).

Power supply connection set

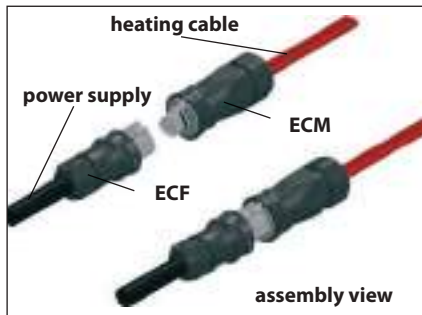

## EC-2 (98300875).

Power supply connection set for 2 cables

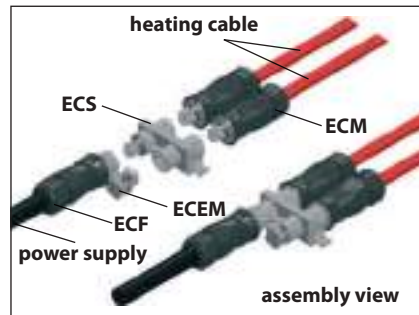

## EC-3 (98300876).

Power supply connection set for 3 cables

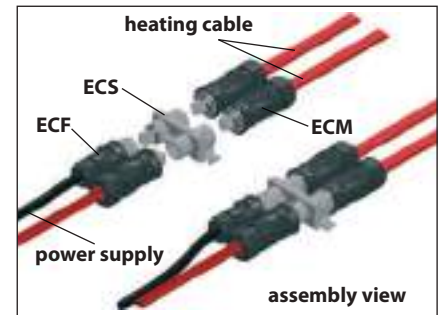

## EC-ETK (98300872).

End plug set

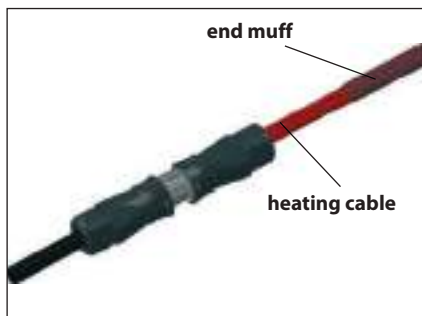

## EC-1 + ETK (98300873).

Power supply connection set with an end plug

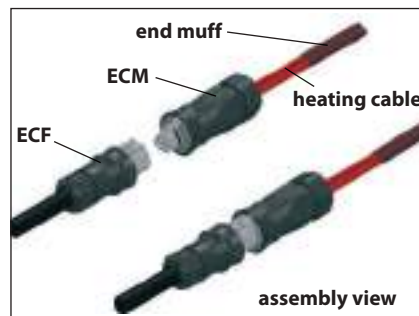

## EC-T1 (98300871).

2 heating cables connection set

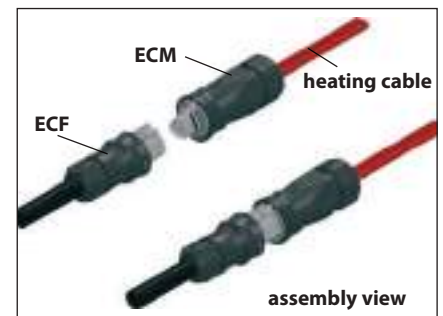

## EC-T2 (98300874).

Set for heating cable branching - 1 to 2

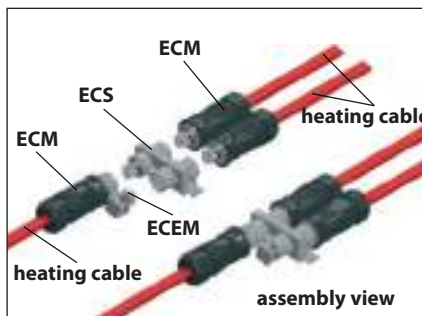

## Example of DEVI EasyConnect appliance

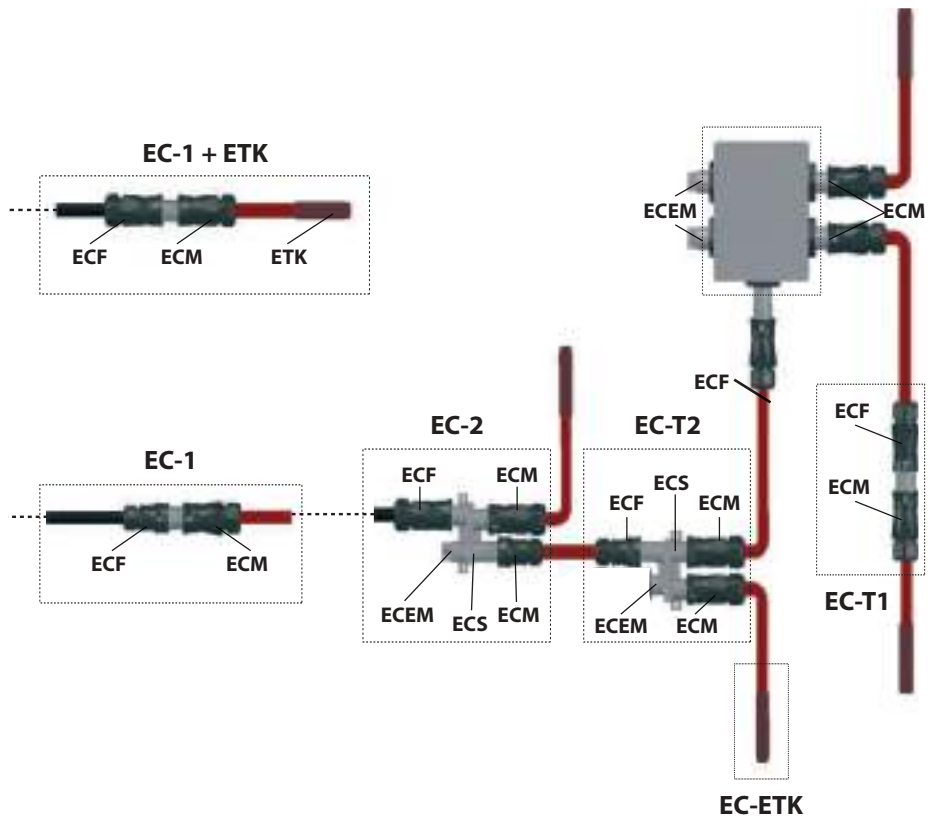

## EC-JB4 (98300877).

Junction box for connecting 4 heating cables - 1 to 4



ECF - socket outlet (Female), ECM - socket plug (Male),  
ECEM - socket plug cover (Male), ECS - distribution block.

## Product overview for the Pipe Frost Protection

Product	Options	Description
Resistive heating cable DEVIflex™	DEVIflex™ 6T, 230 V; DEVIflex™ 10T, 230 V; DEVIflex™ 18T, 230 V	Twin conductor, 100% screen. 6, 10 or 18 W/m (230 V); Ø 6,9 mm. DIN IEC 60800:2009 M2
Resistive heating cable DEVIbasic™	DEVIbasic™ 10S, 230 V, on drum; DEVIbasic™ 20S, 230 V, on drum; DEVIbasic™ 20S, 400 V, on drum	Single conductor, wire screen. 10 W/m (230 V), 20 W/m (230 V/400 V); Ø 5,5 mm. DIN IEC 60800:1992
Resistive heating cable DEVlaqua™	DEVlaqua™ 9T with 3/4"+1" Pipe fitting	Twin conductor, wire screen, 9 W/m (230 V); Ø 5,7 mm Approved for use in drinking water.
Self-limiting heating cable DEVliceguard™	DEVliceguard™ 18, with plug, 2-50 m; DEVliceguard™ 18, on drum	18 W/m @ 0 °C. 11,8 x 5,8 mm.
Self-limiting heating cable DEVpipeguard™	DEVpipeguard™ 10, on drum DEVpipeguard™ 25, on drum DEVpipeguard™ 33, on drum	10 W/m @ 10 °C. 25 W/m @ 10 °C. 33 W/m @ 10 °C. 11,8 x 5,8 mm
Self-limiting heating cable inside pipe DEVpipeheat™ 10 V2	DEVpipeheat™ 10 V2 with plug, 2-25 m. Accessory: 3/4"+1" Pipe fitting (10 bar @ 23 °C)	10 W/m @ 10 °C, 100% screen. 7,7 mm x 5,3 mm.
DEVlreg™ thermostat	DEVlreg™ 330 (5...45 °C)	5...45 °C, 16 A, IP20, DIN rail
DEVlreg™ thermostat	DEVlreg™ 610	-10...+50 °C, 10 A, IP44, wall/pipe installation
Temperature sensor	10 m, PVC	Wire sensor, Ø 8 mm, IP65, NTC 15 kOhm @ 25 °C
Temperature sensor	40 m (Santropene)	Wire sensor, Ø 5 mm, IP67, NTC 15 kOhm @ 25 °C
Assembly kit	DEVlcrimp™ CS2A/CS2B and other assembly kits	For 2-conductor cable
Fixing	Aluminum tape	Glued aluminum tape 38 mm x 50 m; 0,06 mm; max. 75 °C

For details please refer to the DEVI Catalogue.

Various specific assembly kits are available.

# 4. System design

Output of heating cables installed on pipe should not be less than the calculated pipe surface heat loss multiplied by 1,3 safety factor.

In most cases 10W/m output is enough if:

- the pipe diameter does not exceed 50 mm,
- the insulation thickness is at least the same as the pipe diameter,

### Frost protection of pipe systems [W/m]

The table below shows the heat loss for 1 meter of pipe ( $q_{pipe}$ ) for various pipe dimensions, insulation thicknesses and temperatures.

- the temperature of surroundings does not fall below -30 °C.
- the required temperature inside the pipe is 5 °C.

In other words, for the above conditions, the only one 10 W/m cable line (DEVflex™ 10T, etc.) is required.

To define the heat loss follow the pipe diameter (in [mm] or [inch]) at the top bar of the table towards the row with the insulation thickness and using the appropriate temperature

**Note.** For plastic pipes the linear output of resistive heating cables should not exceed 10 W/m. This restriction does not apply to self-limiting cables (SLC).

Following pages will help step-by-step to make a right design choice.

difference you will find the heat loss value at the crossing point. For this table  $\lambda$  of insulation material is 0,04 W/m·K (e.g. mineral wool) and safety factor is 1,3.

### Required minimal outputs in [W/m], for straight pipelines (without flanges, valves or T-branches).

Inside pipe diameter	inch (NPS*)	½	¾	1	1¼	1½	2	2½	3	3½	4	4½	5	6	8	10	12
	mm (DN*)	15	20	25	32	40	50	65	80	90	100	115	125	150	200	250	300
Outside pipe diameter*	mm	21	27	34	42	48	60	73	89	102	114	127	141	168	219	273	324
Insulation thickness	$\Delta T$ , °C	Heat loss for 1 meter of pipe, W/m ( $\lambda = 0,04$ , Safety factor = 1,3)															
10 mm	20	9,8	11,8	14,1	16,8	18,8	22,7	27,0	32	36	40	45	49	58	75	92	109
	25	12,2	14,7	17,6	21,0	23,4	28,4	34	40	46	51	56	62	73	93	115	136
	30	14,6	17,7	21,2	25,2	28,1	34	40	48	55	61	67	74	87	112	139	164
	40	19,5	23,6	28,2	34	38	45	54	64	73	81	89	98	116	149	185	218
	60	29,3	35	42	50	56	68	81	97	109	121	134	148	174	224	277	327
	80	39,0	47	56	67	75	91	108	129	146	162	179	197	232	299	370	436
20 mm	100	48,8	59	71	84	94	114	135	161	182	202	223	246	290	374	462	545
	20	6,1	7,2	8,4	9,8	10,8	12,8	14,9	17,6	19,7	21,7	23,9	26,2	31	39	48	56
	25	7,7	9,0	10,5	12,2	13,5	16,0	18,7	22,0	24,7	27,1	30	33	38	49	60	70
	30	9,2	10,8	12,6	14,6	16,2	19,2	22,4	26,4	30	33	36	39	46	58	72	84
	40	12,2	14,4	16,8	19,5	21,6	25,6	30	35	39	43	48	52	61	78	96	112
	60	18,4	21,6	25,2	29,3	32	38	45	53	59	65	72	78	92	117	143	168
30 mm	80	24,5	28,7	34	39	43	51	60	70	79	87	95	105	122	156	191	224
	100	30,6	36	42	49	54	64	75	88	99	109	119	131	153	195	239	281
	20	4,8	5,6	6,4	7,4	8,1	9,4	10,9	12,7	14,1	15,4	16,9	18,4	21,4	27,0	33	38
	25	6,0	7,0	8,0	9,2	10,1	11,8	13,6	15,8	17,6	19,3	21,1	23,0	26,7	34	41	48
	30	7,3	8,4	9,6	11,0	12,1	14,1	16,3	19,0	21,2	23,2	25,3	27,6	32	40	49	58
	40	9,7	11,2	12,8	14,7	16,1	18,8	21,8	25,3	28,2	31	34	37	43	54	66	77
40 mm	60	14,5	16,7	19,3	22,1	24,2	28,3	33	38	42	46	51	55	64	81	99	115
	80	19,4	22,3	25,7	29,4	32	38	44	51	56	62	68	74	86	108	131	154
	100	24,2	27,9	32	37	40	47	54	63	71	77	84	92	107	135	164	192
	20	4,2	4,7	5,4	6,1	6,7	7,7	8,8	10,2	11,3	12,3	13,4	14,5	16,8	21,0	25,4	29,6
	25	5,2	5,9	6,7	7,7	8,3	9,6	11,0	12,7	14,1	15,4	16,7	18,2	21,0	26,2	32	37
	30	6,2	7,1	8,1	9,2	10,0	11,6	13,2	15,3	16,9	18,4	20,1	21,8	25,2	31	38	44
50 mm	40	8,3	9,5	10,8	12,2	13,3	15,4	17,7	20,4	22,6	24,6	26,7	29,1	34	42	51	59
	60	12,5	14,2	16,2	18,4	20,0	23,1	26,5	31	34	37	40	44	50	63	76	89
	80	16,6	19,0	21,6	24,5	26,6	31	35	41	45	49	53	58	67	84	102	118
	100	20,8	23,7	27,0	31	33	39	44	51	56	61	67	73	84	105	127	148
	20	3,7	4,2	4,8	5,4	5,8	6,7	7,6	8,7	9,6	10,4	11,2	12,2	14,0	17,4	20,9	24,3
	25	4,7	5,3	6,0	6,7	7,3	8,3	9,5	10,8	11,9	13,0	14,1	15,2	17,5	21,7	26,2	30,4
75 mm	30	5,6	6,3	7,1	8,0	8,7	10,0	11,4	13,0	14,3	15,6	16,9	18,3	21,0	26,0	31	36
	40	7,5	8,4	9,5	10,7	11,6	13,3	15,1	17,3	19,1	20,7	22,5	24,4	28,0	35	42	49
	60	11,2	12,7	14,3	16,1	17,4	20,0	22,7	26,0	28,7	31	34	37	42	52	63	73
	80	14,9	16,9	19,0	21,4	23,2	26,6	30	35	38	41	45	49	56	69	84	97
	100	18,6	21,1	23,8	26,8	29,0	33	38	43	48	52	56	61	70	87	105	121
	20	3,1	3,5	3,9	4,3	4,6	5,2	5,8	6,6	7,2	7,8	8,4	9,0	10,2	12,5	14,9	17,2
100 mm	25	3,9	4,3	4,8	5,4	5,8	6,5	7,3	8,3	9,0	9,7	10,5	11,3	12,8	15,6	18,6	21,5
	30	4,7	5,2	5,8	6,4	6,9	7,8	8,8	9,9	10,8	11,7	12,6	13,5	15,4	18,8	22,4	25,7
	40	6,2	6,9	7,7	8,6	9,2	10,4	11,7	13,2	14,4	15,6	16,8	18,0	20,5	25,0	29,8	34
	60	9,3	10,4	11,6	12,9	13,8	15,6	17,5	19,8	21,7	23,3	25,1	27,0	31	38	45	51
	80	12,5	13,9	15,5	17,2	18,4	20,9	23,4	26,4	28,9	31	34	36	41	50	60	69
	100	15,6	17,4	19,3	21,5	23,0	26,1	29,2	33	36	39	42	45	51	63	75	86

\* NPS - Nominal Pipe Size, DN - diamètre nominal/nominal diameter/Durchmesser nach Norm. Values in table can be calculated with help of formula on next page (chapter 4.1).

## 4.1. Step-by-step system design

Following pages provide an easy step-by-step design guide for selection of a DEVI pipe frost protection system.

The recommendations are provided relate both constant wattage cables and self-limiting cables, as well as thermostats and accessories.

The detailed example is provided at the end of this chapter.

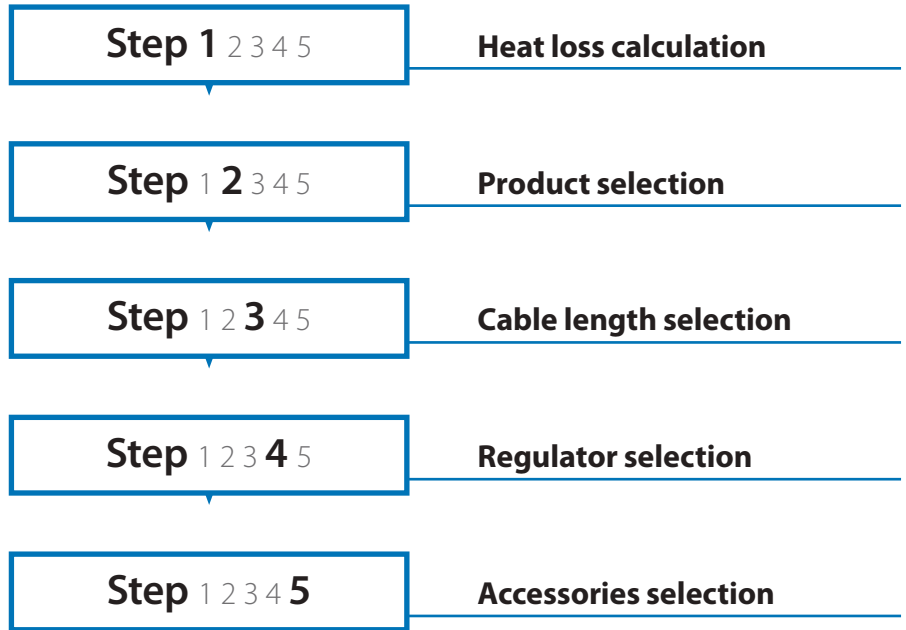

### Step 1 2 3 4 5 Heat loss calculation

The most important factors to define the pipe heat losses are the following:

- Pipe diameter
- Insulation thickness
- Difference between inside (desired maintained temperature) and outside pipe temperatures (e.g. outdoor) temperature of the installation site.

The following formula is used for heat losses calculation for total length of a pipe to be protected:

$$Q[W] = \frac{2 \cdot \pi \cdot \lambda \cdot l \cdot (t_p - t_a)}{\ln(D/d)} \cdot 1,3,$$

where:

- D - Outside pipe diameter incl. insulation, [m],
- d - Pipe diameter without insulation [m],
- l - Total length of pipe, [m],
- $t_p$  - Desired maintained temperature, [°C],
- $t_a$  - Outside temperature, [°C],
- $\lambda$  - Thermal conductivity of insulation, [W/m·K],
- 1,3 - Safety factor.

$\lambda$  value for standard insulation material (like glass wool or styropor), is set to 0,04 W/m·K.

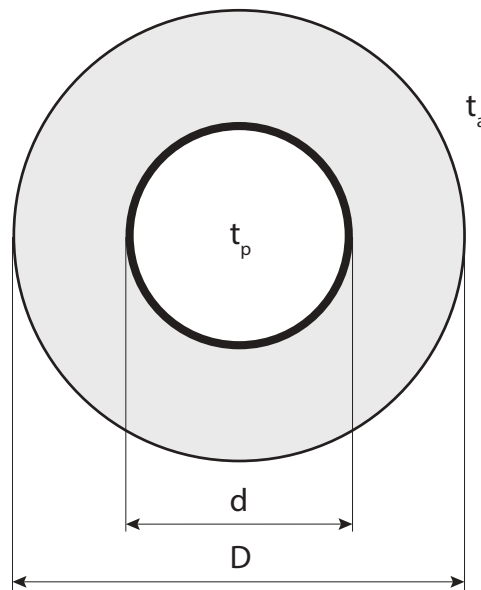

In(D/d)	0,0	0,4	0,7	0,9	1,1	1,3	1,4	1,5	1,6	1,8	1,9	2,1	2,2	2,3	2,7	3,0	3,2
(D/d)	1,0	1,5	2,0	2,5	3,0	3,5	4,0	4,5	5,0	6,0	7,0	8,0	9,0	10,0	15,0	20,0	25,0

Heat loss values from the table on the previous page calculated by the above formula and divided by total pipe length. The obtained values are in [W/m].

Natural logarithm (ln) values for D/d ratio:  $X = D/d$ .



Constant wattage heating cables

Are typically used in case of simple straight pipe lines installed in a similar thermal environment.

In such cases selection of the heating cable directly depends on the pipe length.

In case of installation of new pipes, or longer pipe lines, the use of on-pipe heating cables is preferable.

For shorter or existing pipes installation of in-pipe heating cables is the only feasible or available choice.

There are three different cables for selection with different linear output (6 W/m, 10 W/m or 18 W/m). It's necessary to choose a heating cable with output equal or higher than the one calculated by the formula (including 1,3 safety factor).

Cable outputs are calculated for 230 V. For 220 V the displayed output value in [W] shall be multiplied by 0,91 factor. E.g. DEVIflex™ 10T, 60 m with output of 600 W at 230 V, has the output of only 546 W at 220 V.

Example (see also Step 1)

- Pipe diameter  $d = 65 \text{ mm}$
- Insulation thickness = 20 mm
- Thermal conductivity value for insulation  $\lambda = 0,04$
- Desired temperature  $t_u = +10 \text{ }^\circ\text{C}$
- Minimum outside temperature  $t_o = -20 \text{ }^\circ\text{C}$

Heat loss Q is calculated with help of formula from Step 1 or from table on page 11:  $Q = 16 \text{ W/m}$ .

The choice is for cable with linear output  $\geq 16 \text{ W/m}$ : DEVIflex™ 18T (18 W/m).



DEVIflex™ 6T	
Output [W]	Length [m]
180	30
250	40
310	50
345	60
415	70
500	80
540	90
653	100
720	115
770	129
870	140
915	160
1095	180
1160	190
1260	200

DEVIflex™ 10T	
Output [W]	Length [m]
20	2
40	4
60	6
80	8
100	10
205	20
290	30
390	40
505	50
600	60
695	70
790	80
920	90
990	100
1220	120
1410	140
1575	160
1760	180
1990	200
2050	210

DEVIflex™ 18T	
Output [W]	Length [m]
130	7,3
270	15
395	22
535	29
680	37
820	44
935	52
1075	59
1220	68
1340	74
1485	82
1625	90
1880	105
2135	118
2420	131
2775	155

Self-limiting heating cables (SLC)

SLCs are often used for pipe systems with many branches, because it's easier to adjust the cable length to appropriate pipe length (SLC can be cut to length provided that the maximum cable length is observed).

The self-limiting function, that allows SLC output adjustment based on the pipe temperature, is a rather useful feature. However the self-limiting cable regulation by a thermostat is recommended due to continuous use of the SLC, even if heating is not needed.

When choosing a self-limiting heating cable it's essential to investigate whether the heating cable can provide the required output at the desired temperature.

How to read the graph

Draw a line from the desired temperature value (X-axis) and a calculated heat loss output (Y-axis).

Afterwards find a heating cable with output values higher (Y-axis) than the cross point of temperature and output lines.

Example (see also Step 1)

- Pipe diameter  $d = 65 \text{ mm}$
- Insulation thickness = 20 mm
- Thermal conductivity value for insulation  $\lambda = 0,04$
- Desired temperature  $t_u = +10 \text{ }^\circ\text{C}$
- Minimum outside temperature  $t_o = -20 \text{ }^\circ\text{C}$

Heat loss  $Q$  is calculated by the formula of Step 1 or from the table on page 11:  $Q = 16 \text{ W/m}$ .

The choice is for DEVlceguard™ 18 with linear output of 18 W/m at 10 °C.

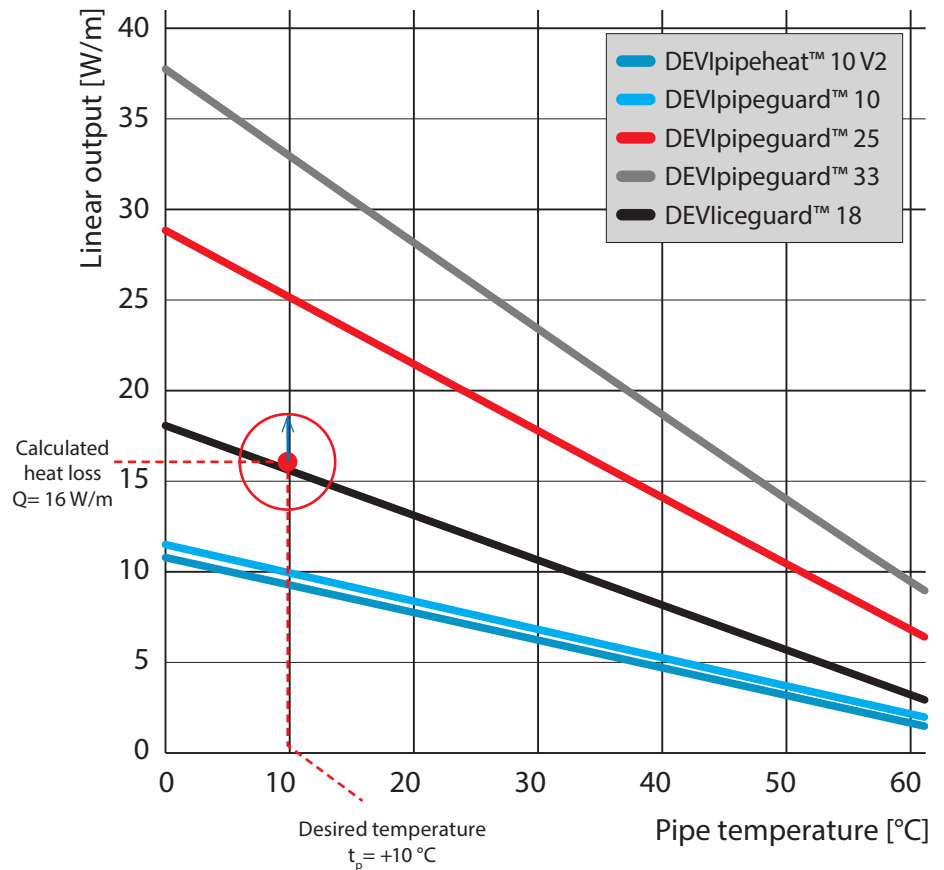

# Step 1 2 3 4 5

## Cable length selection

### Constant wattage heating cables

All DEViflex™ constant wattage heating cables are manufactured with specific lengths. A product to be chosen should be of the same length or longer than the entire length of the pipe to be protected.

If the protected pipe is fitted with some components such as flanges, valves, supports, T-branches, or sprinklers some extra cable length shall be applied. In this case use the calculation formula in chapter 4.1.

#### Important:

It's strictly forbidden to cut a constant wattage cable. In case of surplus cable length it should be wound around the pipe, or for metal pipes only it should be drawn along the pipe at its end.

Length of cable is connected to the power supply and it's used to its full availability. A total length of the cable has to be used. Reducing cable length by its cutting is strictly forbidden.

Spiral winding of heating cable around a pipe gives better heat division and protection, but requires more space around the pipe during installation and thus can be unfeasible in some cases.

For further advice concerning the cable layout please refer to chapter 5.1 (Installation).

#### Example:

Pipe length  $L = 50$  m,  
 $Q = 16$  W/m (as before).

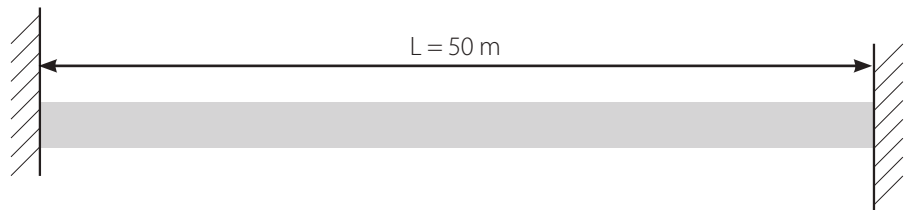

Heating cable of  $L_{\text{cable}} = 52$  m  
 and 935 W output is chosen.

DEViflex™ 6T	
Output (W)	Length (m)
180	30
250	40
310	50
345	60
415	70
500	80
540	90
653	100
720	115
770	129
870	140
915	160
1095	180
1160	190
1260	200

DEViflex™ 10T	
Output (W)	Length (m)
20	2
40	4
60	6
80	8
100	10
205	20
290	30
390	40
505	50
600	60
695	70
790	80
920	90
990	100
1220	120
1410	140
1575	160
1760	180
1990	200
2050	210

DEViflex™ 18T	
Output (W)	Length (m)
130	7,3
270	15
395	22
535	29
680	37
820	44
935	52
1075	59
1220	68
1340	74
1485	82
1625	90
1880	105
2135	118
2420	131
2775	155

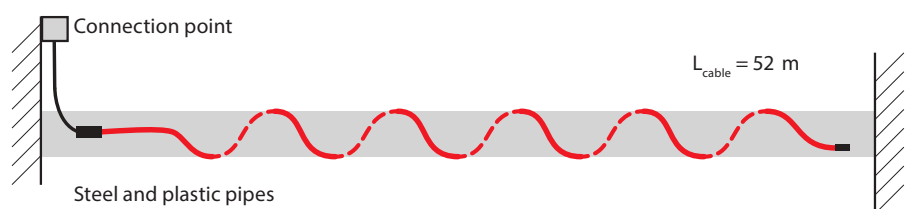
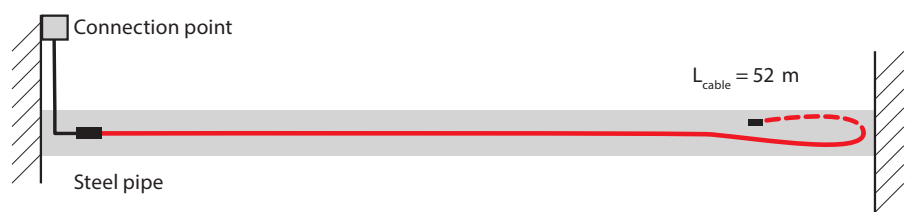

# Step 1 2 3 4 5

## Cable length selection

### Self-limiting heating cables

Self-limiting heating cables are available on drums and ready to be cut to length. The maximum length of SLC is defined by: a cable type, start-up temperature and a fuse size.

The length of a self-limiting heating cable should be enlarged in case of presence of valves, flanges and alike, in the same way as for constant wattage cables (see chapter 4.1 for further details).

**Example:**

Pipe length  $L = 50\text{ m}$ ,  
 $Q = 16\text{ W/m}$ .

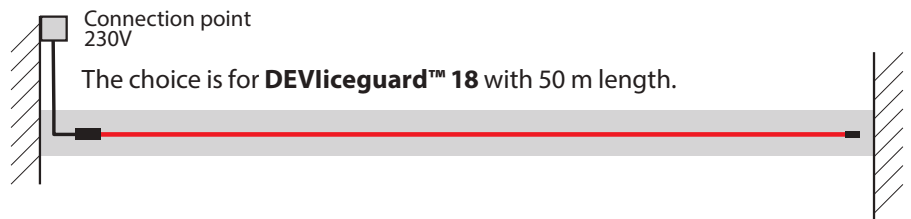
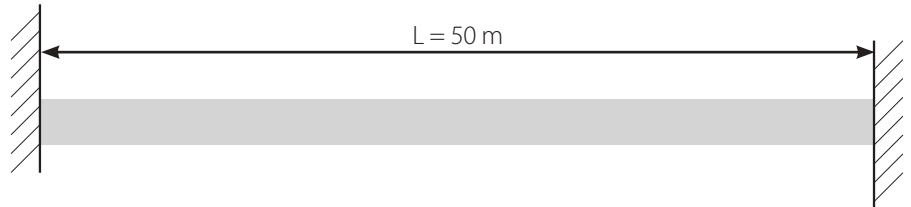

### Maximum length of connected self-limiting heating cables

The maximum length of the combined (all parts) self-limiting heating cables can't exceed the value for this cable included in the table below.

Total cable length

$$L_{\text{total}} = \text{part 1} + \text{part 2} + \text{part 3} \leq \text{max. allowed length } (L_{\text{max cable}})$$

**Example:** At start up temperature of  $+10\text{ }^\circ\text{C}$ , 10 A fuse and DEVliceguard™ 18,  $L_{\text{max cable}} = 58\text{ m}$

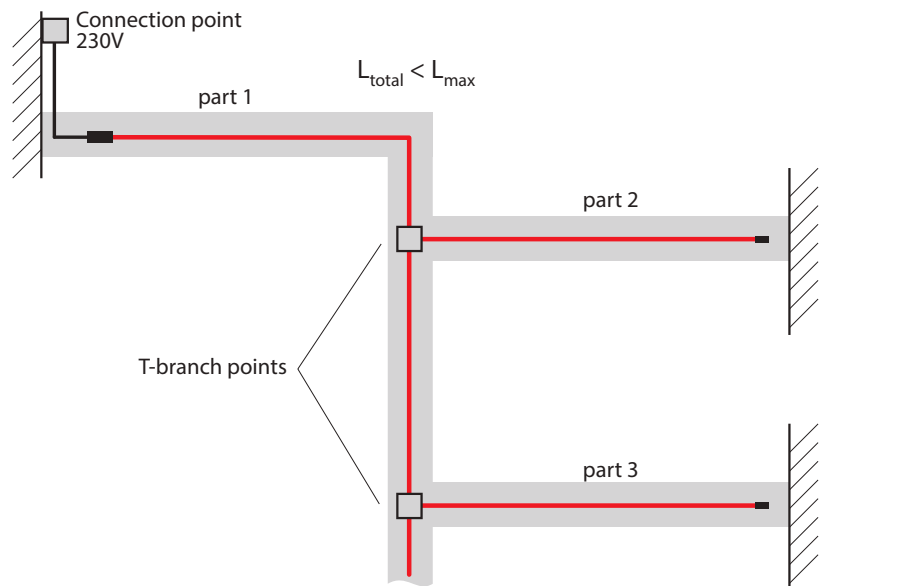

Maximum length values for SLCs at different start-up temperatures and fuse sizes

Start-up temperature	Max. length of heating cable at 230 V [m]															
	DEVpipeguard™ 10				DEVliceguard™ 18				DEVpipeguard™ 25				DEVpipeguard™ 33			
	Fuse size of C characteristic															
	10A	16A	25A	32A	10A	16A	20A	25A	10A	16A	25A	32A	10A	16A	25A	32A
-20°C	97	156	226	226	35	56	70	87	46	74	116	146	28	45	71	91
-10°C	110	176	226	226	39	63	79	99	52	84	131	146	32	51	81	103
0°C	119	191	226	226	43	70	88	110	58	93	146	146	36	58	91	117
+10°C	119	191	226	226	58	93	116	145	58	93	146	146	42	67	105	120

Maximum cable lengths are defined for the case when the cable is switched on being unheated.

In this case its power consumption will be in the range of 3-7 times of its nominal value, when reaching its operating temperature.

Start-up temperature is the possible min. ambient temperature at which the SLC is turned on.



### Temperature regulation

Constant wattage as well as self-limiting heating cables require a thermostat for regulation. The thermostat ensures maintaining constant temperature and turning the heating on while limiting energy consumption, even for SLCs that are constantly on and even if it's not required.

The thermostat selection depends on the specific installation. The most common systems are described on this page, either with a sensor placed directly onto the pipe (under the insulation) or based on the air temperature sensor.

Systems with a sensor installed directly on the pipe to be protected is of the most use.

### Temperature regulation using air sensor

This system is based on the air sensor that is installed close to the protected pipe and that turns on the heating when the ambient temperature falls below the set value.

### Such set up is primarily used in cooperation with self-limiting heating cables.

If the size of the heating elements exceeds the maximum limit defined by the thermostat, the connection to more heating elements needs to be ensured by means of relays / contactors. In such installations, one thermostat can regulate several heating elements.

Advantage of this system is mostly visualized in regulating of pipe frost-protection systems, where pipes have different sizes and insulation thickness.

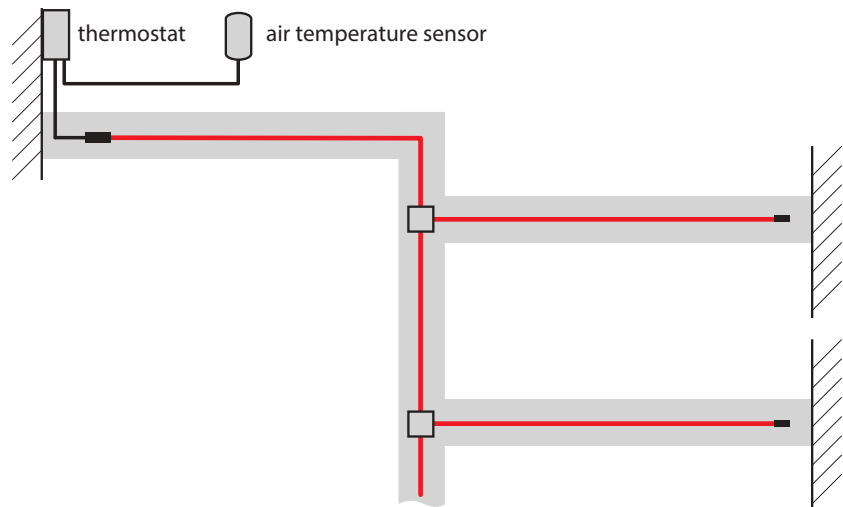

Pipe of different diameters. Installation completed with self-limiting heating cable.

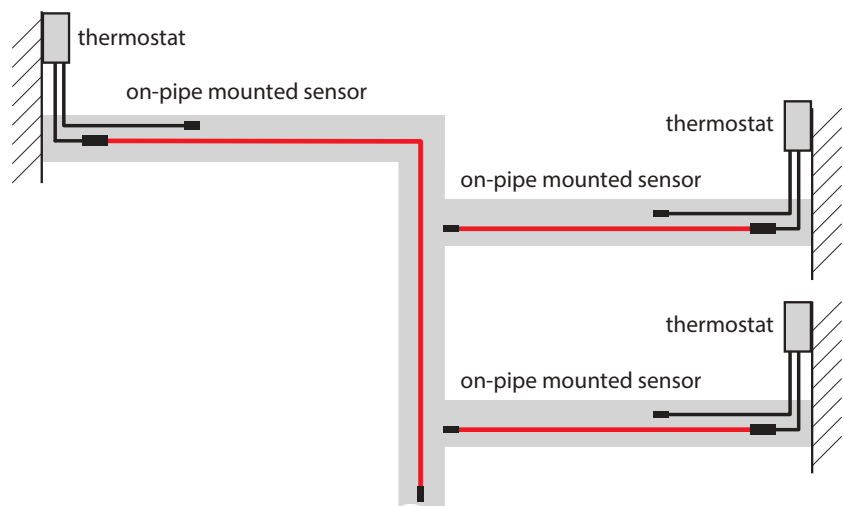

Pipe of different diameters. Installation completed with constant wattage heating cable.

### Temperature regulation using on-pipe sensors

This type of installation, where the sensor is placed directly on pipe under insulation, is more precise and energy efficient way of regulation than the air sensor.

On-pipe sensor regulation is often used for systems with many pipes and branches, with different temperature settings or conditions.

It requires, as shown on the picture, more thermostats, and is necessary when:

- pipes have different sizes or insulation thicknesses;
- changing temperature conditions, e.g. pipe from building to outside, and back to the building, or installed above or underground;
- mixed pipes delivering stagnant and moving water;
- pipes delivering any fluid sensitive to rapid temperature changes

This type of regulation, with on-pipe sensor, is required when installation is performed with constant wattage cables, or on plastic pipes (e.g. PVC, PP, PE, PE-X).

Choice of the thermostat also relates to its temperature range, expected place of installation (in DIN-rail box or outside) and any additional requirements.

### Sensor placing

Sensors for pipe frost-protection systems should be installed in a place that is the most representative for the installation, i.e. in the expected coldest point of this installation (e.g. on pipe part facing the entrance to the unheated parking area).

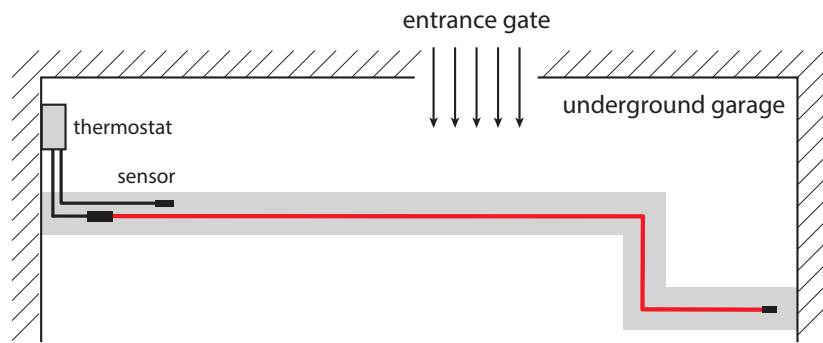

**Example:**  
Pipe length 50 m, a frost protection installation with a DEVliceguard™ 18 self-limiting cable with DIN-rail thermostat.  
Maintained temperature = +10 °C.

Solution is DEVIreg™ 330 (-10...+10 °C), but DEVIreg™ 330 (+5...+45 °C) can also be considered.  
For more information please refer to chapter 3 (Products) or to the DEVI Product Catalogue.

## Step 1 2 3 4 5

### Accessories selection

#### Constant wattage and SLC cables

In case of metal pipes the heating cable can be attached to the pipe by means of an aluminum tape placed at intervals of approx. 1 meter. Subsequently, the total length of the heating cable needs to be covered with aluminum tape, securing cables to the pipe.

In case of the plastic pipes, before mounting the cable onto the pipe, the aluminum tape needs to be applied on the pipe where the heating cable will be placed. Other part of the installation steps resembles that of the installation on metal pipe.

#### Selection of connection boxes and accessories for constant wattage cables

Constant wattage cables are fitted with connection cables (power connection), so no additional connection accessories are needed.

If electric connection point requires, a connection box can be used.

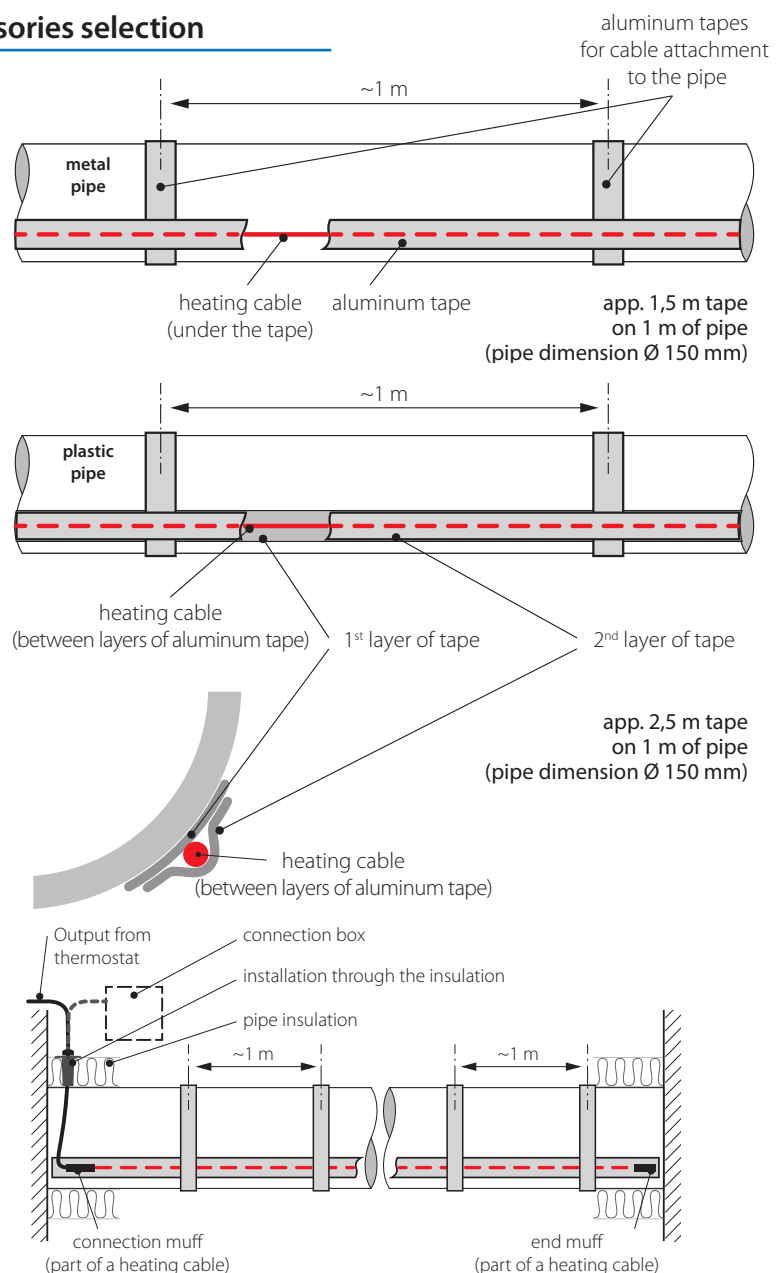

## Selection of connection accessories for self-limiting heating cables

### 1. Complete set for 1 branch:

- 1 x Connection box
- 3 x Connection to box
- 1 x Bracket
- 3 x Through Insulation set

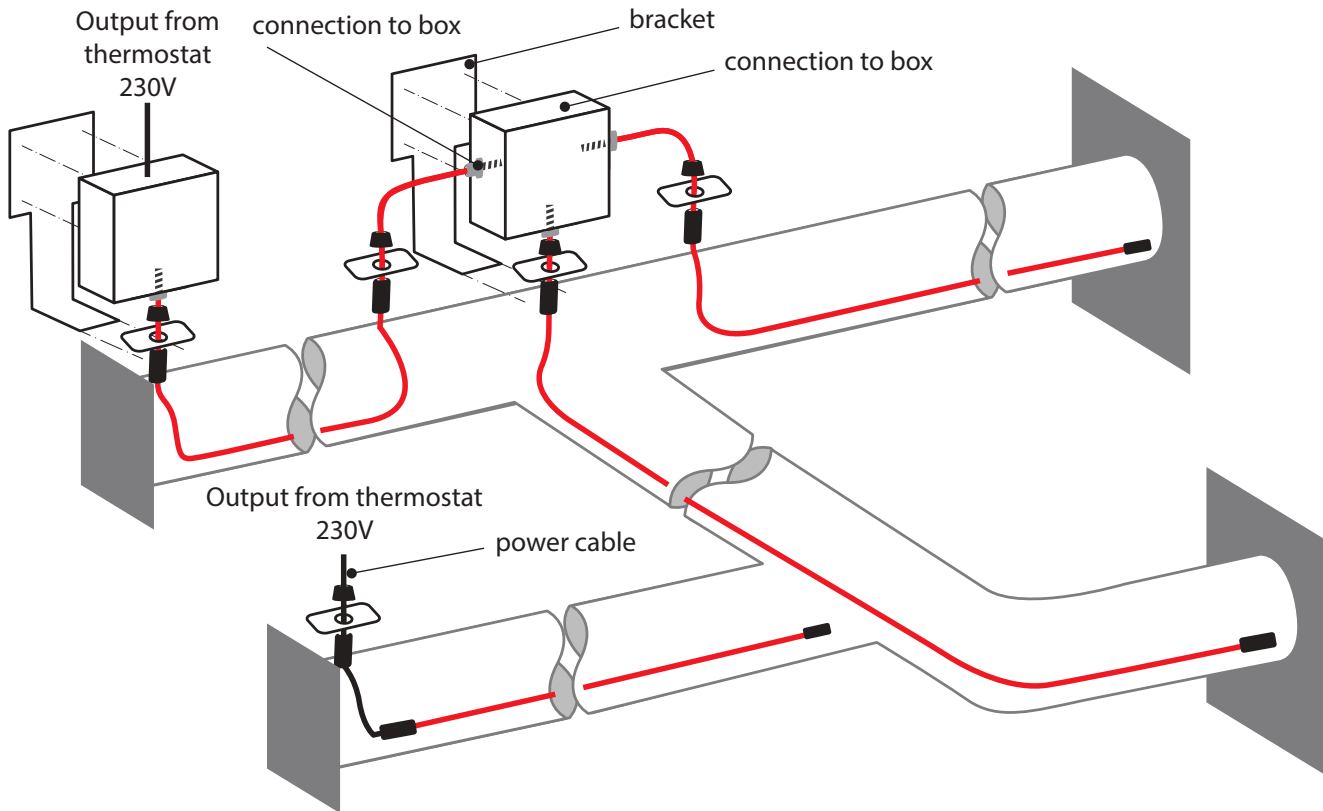

### 2. Set of accessories for connection to power supply (option no. 1):

- 1 x Connection box
- 1 x Connection to box
- 1 x Bracket
- 1 x Through Insulation set

Connection sets for connection to box and SLC to SLC contain also end elements.

### 3. Set of accessories for connection to power supply (option no. 2):

- 1 x SLC to SLC connection set
- 1 x Through Insulation set

Connection to power supply can be done with a heating cable connected via connection box (option no. 1), or end up with cold tail connected with help of option no. 2.

Beside shrink tube connection sets, DEVI provides a wide range of easy-fix connection sets for self-limiting heating cables.

For more details please see chapter 3 (Products) and the DEVI Product Catalogue.

# 5. Installation

## 5.1. General information

### Pipe conditions

Before installing heating cables it is important to check the pipe for any signs of damage or leakage.

The pipes should be insulated as this reduces the heat losses considerably. This applies for all pipes whether they are below or above the ground.

The cable should be attached to the pipe gently, so it does not get damaged. The entire length of the cable should be attached to the pipe with aluminum tape and NOT plastic tape (e.g. PVC), as it contains plasticizers.

The cable should be laid in such a manner to avoid sharp edges on the pipe. Treading on cables should be avoided and cables should be treated carefully at all times.

All pipe trenches should be distinctly marked to indicate that heating cables have been installed on/ in them. It should also be marked with a distinct warning sign, e.g. **“WARNING: 230 VOLT HEATING CABLES”**.

Insulated pipes must be marked with a warning sign placed on the outside of the insulation material.

Heating cable should not be pulled with more than 25 kg.

### Electrical conditions

The screen of the heating cables must be earthed in accordance with the local electricity laws.

The resistance and the insulating resistance of the heating cable must be checked before and after installation. The resistance value must be as indicated on the label of the connection box.

The sensor cable can be extended to any reasonable length using a cable of min  $2 \times 0,75 \text{ mm}^2$ .

The cable is attached to the pipe with strips of aluminum tape placed at intervals of approx. 1 meter. When the heating cable has been attached to the pipe, the entire length of the heating cable must be covered with lanes of aluminum tape. This prevents the heating cable from getting into direct contact with the insulation material and ensures a tight fit between the pipe surface and the heating cable.

Before the heating cable is attached to the plastic pipe, a full lane of aluminum tape should be applied to the pipe for the cable to lie on. This ensures a better heat distribution to the pipe. Cables should be attached at the lower part of the pipe or/and symmetrically around the pipe.

The connection muff between the heating cable and the cold tail should also be fixed with aluminum tape.

The sensor cable is attached to the pipe in the same way as the heating cable. The tip at the end of the sensor should be covered with aluminum tape and be positioned centrally between the cable lines and on top of the pipe, if possible.

The heating cable must not be led through valves. The heating cable is relatively stiff that makes the installation easier.



The cable must be evenly spread and the crossing of resistive cables must be strictly avoided.

Pipes are usually insulated with plastic foam, mineral wool or another kind of insulation, which can range in thickness, typically not less than the pipe diameter.

The insulation should be protected against damp and moisture that could damage the insulation and reduce its efficiency.

Ensure that insulation with bigger inner diameter is chosen, taking into account that the pipe diameter is increased due to heating cable installation.

### Below ground installation

If cables are installed above the ground in trays, it should be safe and solid. It should be marked with a distinct warning sign, e.g. **“WARNING: 230 VOLT HEATING CABLES”**.

When heating cables are installed below the ground, a plastic tape (red, yellow etc.) is laid on top of the pipes/ installation to indicate that cables are placed just below.

For this type of installation it is necessary to measure the required pipe run precisely, as the cable cannot be cut or bent in a loop.

You will need an appropriate DEVIcrimp™ assembly kit to perform cold tail connections and end muff of heating cables on drums. For instance, DEVIcrimp™ assembly/ repair kit 2-cond. CS2A/CS2B (product number: 18055350).



## Installation examples

### Installation on Special Flanges and Pumps

Always observe the minimum tolerable bending diameter of 25 mm for resistive cables and 64 mm for self-limiting cable.

Heating cables on specials, valves etc. should always be positioned so that they are easily accessible and replaceable in connection with inspection and repair and so that it will not be necessary to cut them!

You can avoid this problem when there is sufficient cable wrapped in a spiral around the specials.

### Calculation formulas

Centre-centre (C-C) distance for cables wrapped in a spiral:

$$C-C = \pi \cdot d \cdot \sqrt{\frac{1}{n^2 - 1}}$$

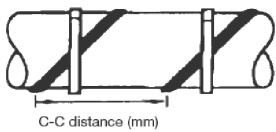

Total length of heating cable:

$$L_{\text{cable}} [\text{m}] = n \cdot L_{\text{pipe}} + 0,5 \cdot (C + FV + 2 \cdot T)$$



Example of cable mounting on a flange.



Example of mounting a self-limiting cable on pipe with use of connection box and metal bracket.

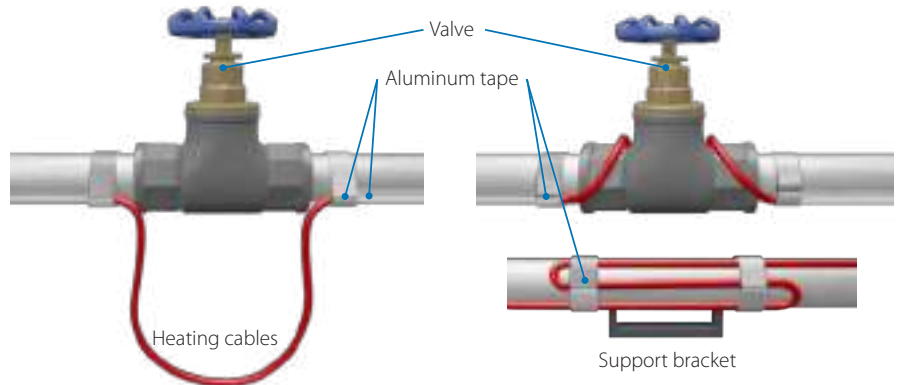

Mounting example around a valve and a support flange.

where:

d - Outer pipe diameter;

n - Number of cable lines (min. 2 for DN125-200).

Integer = straight lines (easier installation).

Decimal = twisted around pipe;

C-C - Centre distance for twisted cable, [mm];

$L_{\text{cable}}$  - Total length of heating cable, [m]. Observe max. length for SLC (see product sheets);

C - Number of cable connections (0,5 m cable each);

FV - Number of flanges/valves (0,5 m cable each);

T - Number of T-branches (1 m cable each).

### Some centre-centre fixing distances when more than 1 meter cable is used on a 1 meter pipe.

Outer pipe diameter	Inner pipe diameter (DN)	Inner pipe diameter	Cable length in [m]								
			1,1	1,2	1,3	1,4	1,5	1,6	1,7	1,8	1,9
[mm]	[mm]	[inch]	C-C distance [mm]								
34	25	1	233	161	129	109	96	86	78	71	66
42	32	1 ¼	288	199	159	135	118	106	96	88	82
48	40	1 ½	329	227	182	154	135	121	110	101	93
60	50	2	411	284	227	192	169	151	137	126	117
76	65	2 ½	521	360	287	244	214	191	174	160	148
89	80	3	610	422	337	285	250	224	203	187	173
102	90	3 ½	699	483	386	327	287	257	233	214	198
114	100	4	782	540	431	366	320	287	261	239	222
141	125	5	967	668	533	452	396	355	322	296	274
168	150	6	1152	796	635	539	472	423	384	353	327
219	200	8	1501	1037	828	702	615	551	500	460	426

## Quick solution finder

If you don't need to make a heat loss calculation, the following tables will help you quickly to find a correct product for frost protection of pipes.

## How to use the table below?

Based on known pipe diameter e.g. Ø60 mm, with 20 mm insulation and ΔT of 30K:

- ❶ Find DN or NPS pipe size in the top bar of the table (e.g. DN 65).
- ❷ Find the temperature difference (ΔT), in the outmost left column (e.g. 30 mm).
- ❸ Find the insulation thickness in the corresponding row (e.g. 30 mm).
- ❹ Follow the vertical and horizontal lines, until they meet.

According to the table, when looking up into table on the previous page, a minimum output to be installed to protect the pipe from freezing is: 15-25 W/m.

Remember to choose preferably the higher output option, hence 20-25 W/m.

**Table presenting the necessary minimal outputs in [W/m] for straight pipelines (colors and corresponding W/m in table below).**

ΔT [°C]	Insulation [mm]	Specific pipe heat loss $q_{\text{pipe}}$											
		Nominal pipe size NPS [inch], DN [mm]											
		½" 15	¾" 20	1" 25	1¼" 32	1½" 40	2" 50	2½" 65	3" 80	4" 100	5" 125	6" 150	8" 200
20	10												
	20												
	30												
	40												
	50												
30	10												
	20												
	30												
	40												
	50												
40	10												
	20												
	30												
	40												
	50												

**Find an appropriate type and number of heating cables to protect the pipe in the following table.**

Number of cable lines		Cable Output $q_{\text{cable}}$ [W/m]					
		0 - 6	6 - 10	10 - 15	15 - 25	25 - 50	>50
<b>DEViflex™ constant wattage</b>	DEViflex™ 6T	1	2				
	DEVlaqua™ 9T (in-pipe)	1	1				
	DEViflex™ 10T	1	1	2	2-3	Max. 4	More insulation required
	DEViflex™ 18T	1	1	1	2	Max. 3	
<b>Self Limiting Cable</b>	DEVipipeheat™ 10 V2	1	1				
	DEVipipeguard™10	1	1	2			
	DEVipipeguard™15			1	2		
	DEVipipeguard™ 25			1	1	2	

## Example

### Quick solution finder

A 12 meter DN50 (Ø 60 mm) drain pipe with 20 mm insulation and a drain valve needs frost protection down to -25 °C (Δt = +5 °C - (-25 °C) = 30 °C).

The specific pipe heat loss  $q_{\text{pipe}}$  depends on the pipe diameter, insulation thickness and temperature difference. The specific pipe heat loss  $q_{\text{pipe}}$  from the calculation table above - 15-25 W/m (yellow, marked ❺).

### Calculation by formula on p. 12.

Exact pipe heat loss:

$$q_{\text{pipe}} = \frac{2\pi \cdot \lambda \cdot \Delta t}{\ln \frac{D}{d}} \cdot 1,3 = \frac{2\pi \cdot 0,04 \cdot 30}{\ln \frac{60+20+20}{60}} \cdot 1,3 = 19,2 \frac{\text{W}}{\text{m}}$$

Solution:

1 line DEVipipeguard 25 W/m with 1 cable connection is chosen.

Cable length:

$$L_{\text{cable}} = n \cdot L_{\text{pipe}} + 0,5 \cdot (C + FV + 2 \cdot T) = 1 \cdot 12 + 0,5 \cdot (1 \cdot 0,5 + 1 + 2 \cdot 0) = 13 \text{ m}$$

As Devireg™ 610 controller with a sensor cable is chosen to be attached between pipe and insulation.

Optionally: 2 parallel lines of DEViflex™ 10T, with a nearest length of 30 m can be chosen. Cable should be wrapped a little, because length is more than calculated: 2 · 13 m = 26 m.

## 5.2 Installation specifics

There are several ways of the cable attachment to the pipe:

1. One or more cables are led in a straight line along the side of the pipe, see fig. 7 and fig. 8.
2. The cable is attached to the pipe in waves or a spiral, see fig. 9.
3. The cable is installed inside the pipe, see fig. 10. The Special Pipe fitting (3/4"+1", 10 bar @ 23 °C; included in DEVIaqua™ is required for heating cable connection to the pipe, see fig. 11.

The heating cable is mounted directly on the pipe and secured with aluminum tape, ensuring optimal contact (heat transfer) between the cable and the pipe. The same applies for wire sensors.

Before the heating cable is attached to the plastic pipe, a full lane of aluminum tape should be applied to the pipe for the cable to lie on.

Fig. 12 shows the recommended ways to mount the cable lines, depending on the amount of heating cables to place on the pipe.

The temperature sensor should be mounted at 90 degrees from the heating cable, counting around the perimeter of the pipe, or at least 5 cm away from it.

But preferably at the opposite side of the pipe, compared to placement of the heating cable.

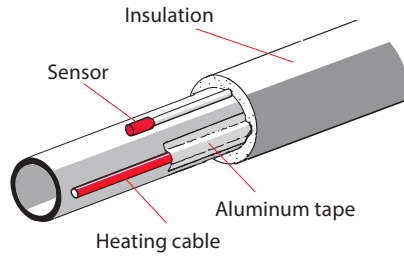

Fig. 7

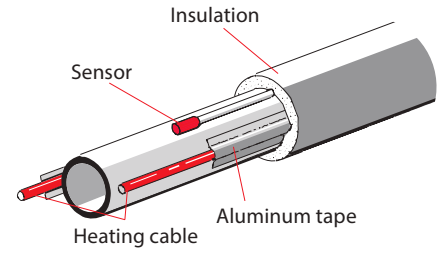

Fig. 8

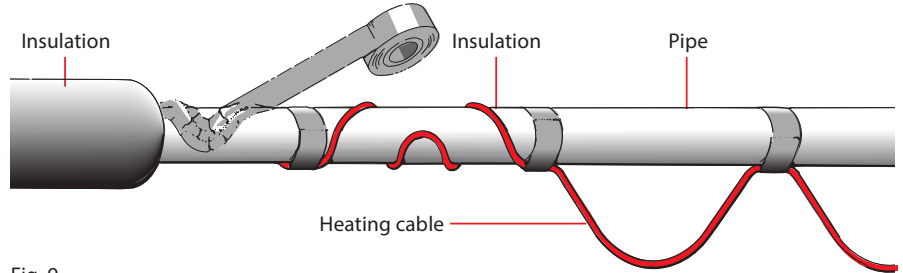

Fig. 9

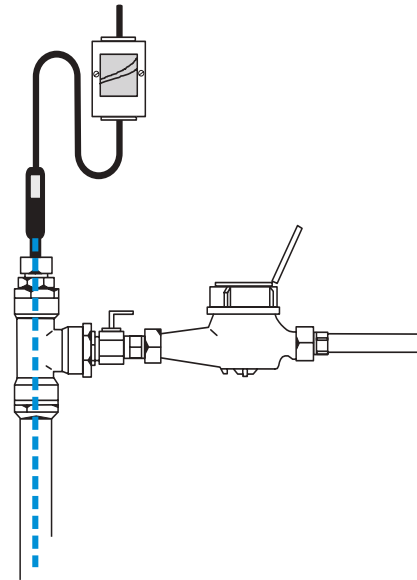

Fig. 10



Fig. 11

### Mounting of heating cables on pipes with large diameter (> Ø 100 mm)

In case of larger pipe diameters it's strongly advised to use more, evenly divided, lengths of heating cable, with lower linear output.

#### Example:

Pipe diameter size  $\varnothing = 150$  mm, with a calculated heat loss of  $Q = 30$  W/m, it's advisable to use 2 lengths of cable with linear output of 18 W/m, than 1 cable with output of 33 W/m.

Pipe diameter	Number of parallel running lines of heating cable
20 – 100	1
125 – 200	2
250 – 400	3
450 – 600	4

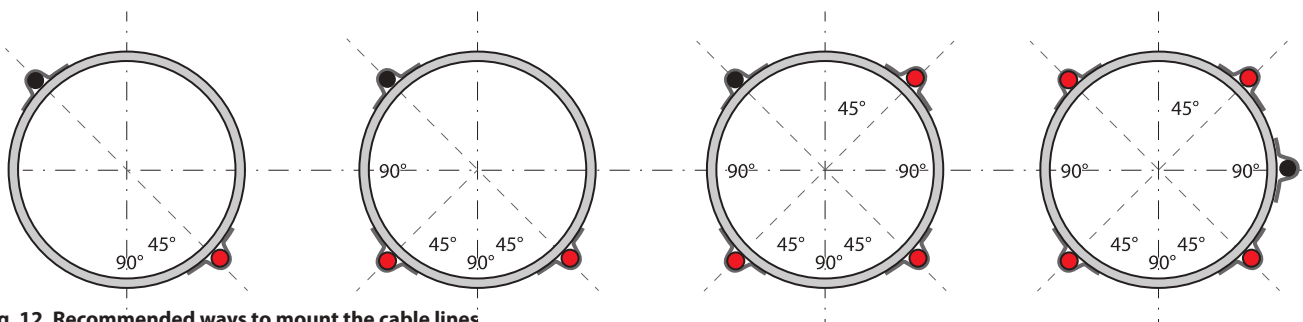

Fig. 12. Recommended ways to mount the cable lines.

### Example of a solution with use of self-limiting heating cables

If the maximum length of self-limiting heating cable exceeds the length displayed on page 16 (under: choice of cable length), it needs to be divided into smaller portions.

#### Example:

With choice of DEVPipeguard™ 10, where the total length of the pipe is 256 m.

Expected start-up temperature is -20 °C, desired pipe temperature is  $t = +5$  °C, and a maximum available fuse size is: 16 A. From a table on page 16, the maximal cable length for this SLC is only: 156 m. It will be necessary to divide the pipe in 2 independent circuits, with separate power supply points, as shown on the picture.

Example of division:

Circuit 1: part 1 + part 2 = 156 m

Circuit 2: part 3 + part 4 = 100 m

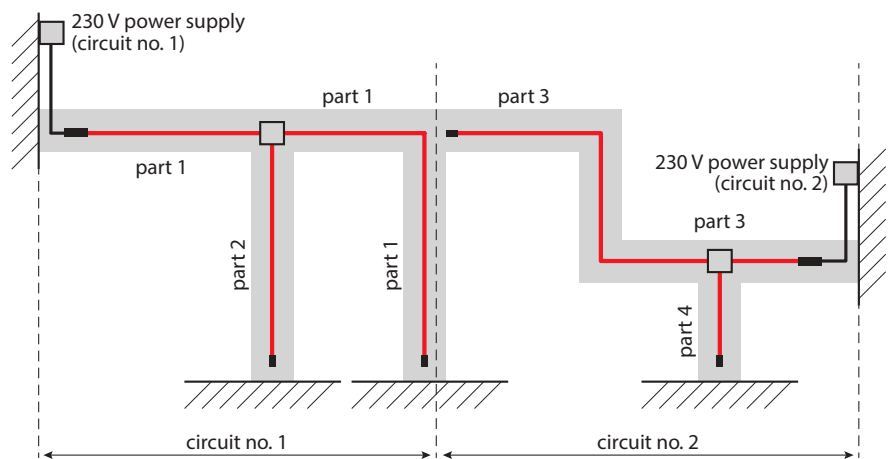

Division in circuits – self-limiting heating cables

### Example of a solution with use of constant wattage heating cables

In case of the constant wattage heating cables, the maximal length of the circuit is limited by the maximum allowed length of the heating cable.

Because the constant heating cables are not allowed to be cut, at each T-branch, a new cable is connected. Each pipe needs to have a heating cable chosen to accommodate its length.

#### Example:

For frost protection of a metal pipe shown on the picture, following solution was chosen.

- Heating cable no. 1: DEViflex™ 10T, 140 m
- Heating cable no. 2: DEViflex™ 10T, 40 m
- Heating cable no. 3: DEViflex™ 10T, 40 m
- Heating cable no. 4: DEViflex™ 10T, 30 m

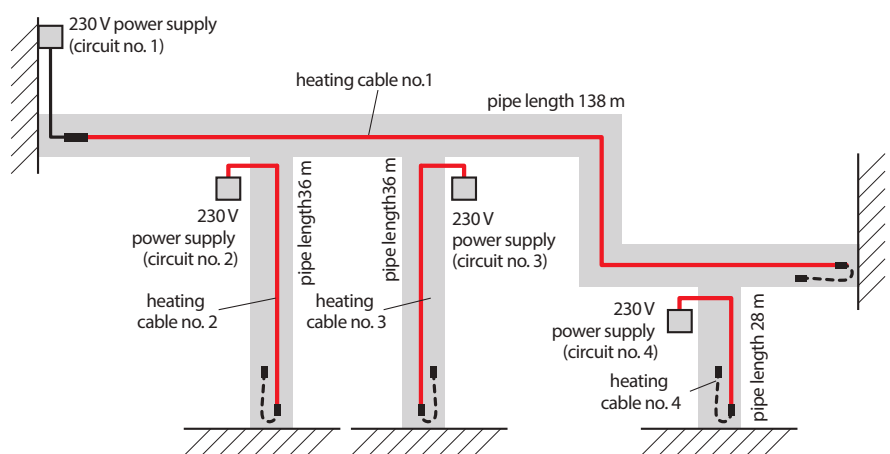

Division in circuits – constant wattage heating cables

## 5.3 Installation Summary

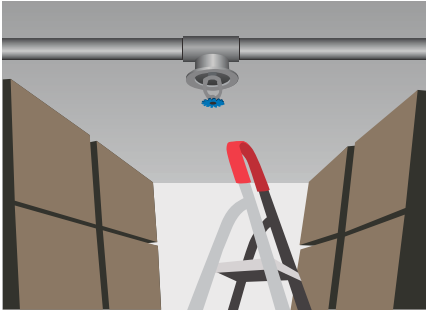

1. Check the pipe system to be heated and make sure that the pipes are dry, smooth and tight. Check and prepare the switch board.

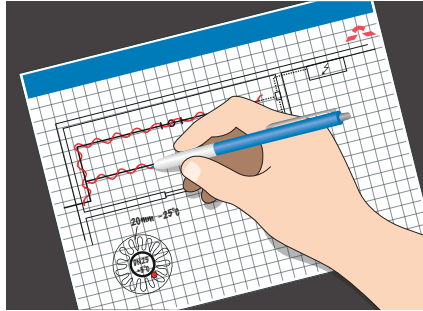

2. Draw a plan positioning cable(s), sensors and thermostat, cable connections, cold tail, connection box, cable paths and switch board.

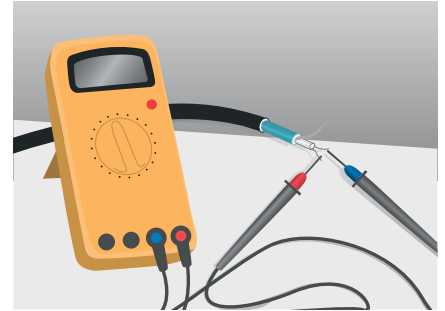

3. Check the insulation resistance and Ohm rating of the heating cables. Compare the Ohm rating with the nominal written on the cable label.

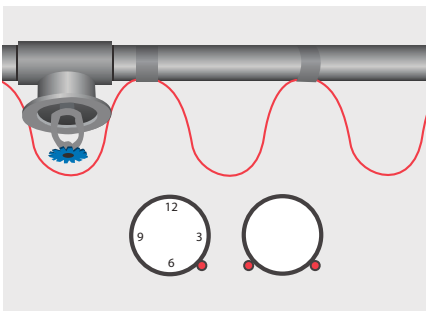

4. Twisted lines are attached as shown for every approx. 1 m pipe with aluminum tape. Straight lines must be fitted as shown at 5 or 7 o'clock. In-pipe cables are fitted directly into the pipe and tightened.

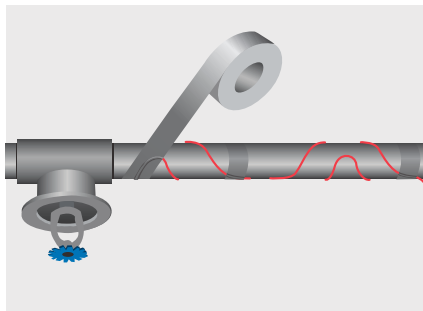

5. Apply aluminum tape below (mandatory for plastic pipes) and on top on the whole length of the cable. Make sure that the cables do not cross sharp edges without relief and that any constant wattage cables do not cross back on itself. Attach the cable securely to the pipe with use of tape and taking care of preventing appearance of air pockets.

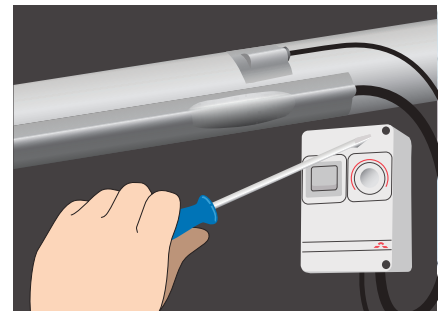

6. Attach and cover the sensor and the tip on top of the pipe with aluminum tape. Extend cold tails / terminate cables and place connections dry. Mount connection box on the pipe or close to the pipe and install the thermostat next to the pipe.

### Commissioning

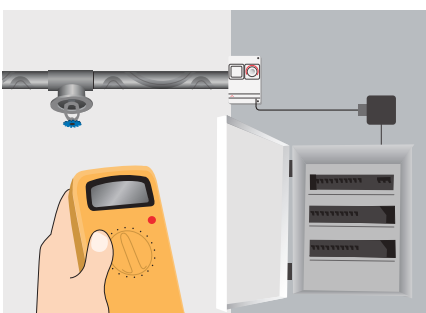

7. Re-check the insulation resistance and also Ohm rating for constant wattage cables. Connect cables to connection boxes and to the switch board.

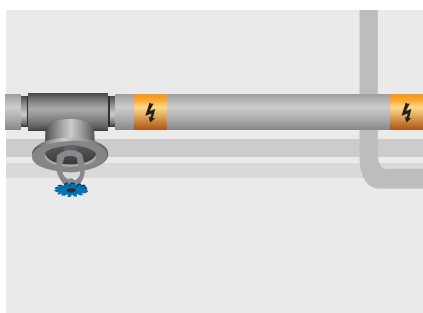

8. After insulation, place safety marking tape on the insulation jacket or pipe trenches for every 5 m. In subsurface installations, a cover ribbon with a warning sign must be laid 10 cm above the cables.

9. Re-check and compare the insulation resistance and also Ohm rating for constant wattage cables and earth resistance.

10. The DEVIreg™ thermostat must be commissioned as prescribed in the thermostat manual. Recommended pipe temperature setting is +3 to +6 °C.

11. Train the end user or daily supervisor in the operation and maintenance of the frost protection system.

12. Before every heating season, check for faults in the switchboard, thermostat and sensors. Re-check and compare the insulation resistance and also Ohm rating for constant wattage cables and earth resistance.



## 5.4 Important

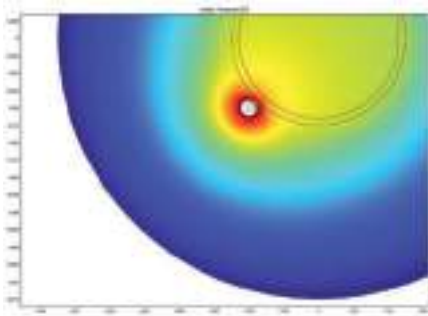

No alutape overheats constant wattage cables. SLC will limit itself and heat insufficiently.

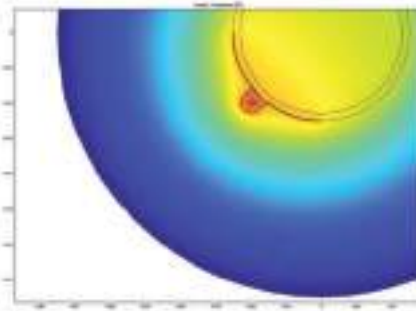

Alutape above and below the cable gives better performance. 50 mm insulation maintains  $\Delta t = 50K$

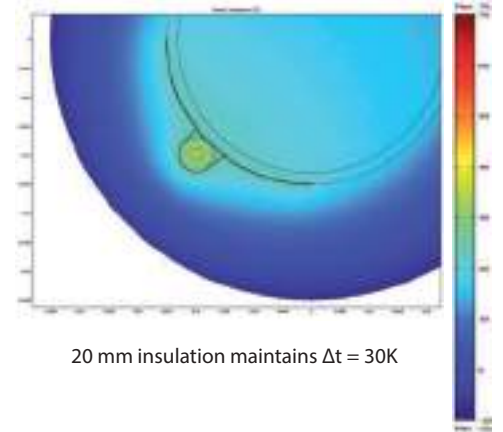

20 mm insulation maintains  $\Delta t = 30K$

### Temperature distribution

Aluminum tape and insulation are important when it comes to performance and very important in relation to plastic pipes. A DN50 plastic pipe (e.g. PP) with 10 W/m at reference temperature  $-10^{\circ}\text{C}$  is shown under 3 different installations.

### Self-Limiting Cables and standby savings with thermostat

Always install a thermostat for self-limiting cables  $>3\text{ m}$  as it

- prolongs the cable lifetime;
- saves the stand by energy consumption;
- leaves e.g. drinking water cold and fresh, when no heat is needed.

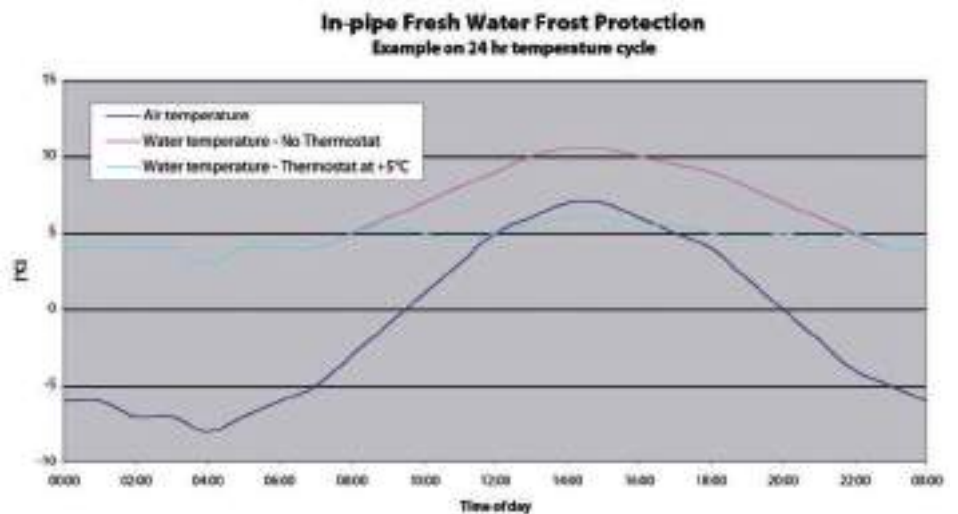



## 6. Cases

### THE GAS TURBINE PLANT, Tereshkovo, Russia

Pipe tracing.

Project size:

DEVipeeguard™ 33 - 170 m

DEVipeeguard™ 25 - 635 m

DEVireg™ 316 (10...+50 °C) - 17 pcs

Outdoor sensor GB IP-44 - 17 pcs

Connection kit for SL cables - 160 pcs

DEVIfast™ (25m) - 36 pcs

Alutape 38 mm x 50 m - 1400 m



### SPAR ZENTRALE SALZBURG, Salzburg, Austria

Frost protection system on water pipes.

Project size:

DEVipeeguard™ 10 - 700 m

Centrally placed regulators- 25 pcs.

